

Design of Deep Beam (Transfer Girder) Using Strut-and-Tie Model (ACI 318-11)

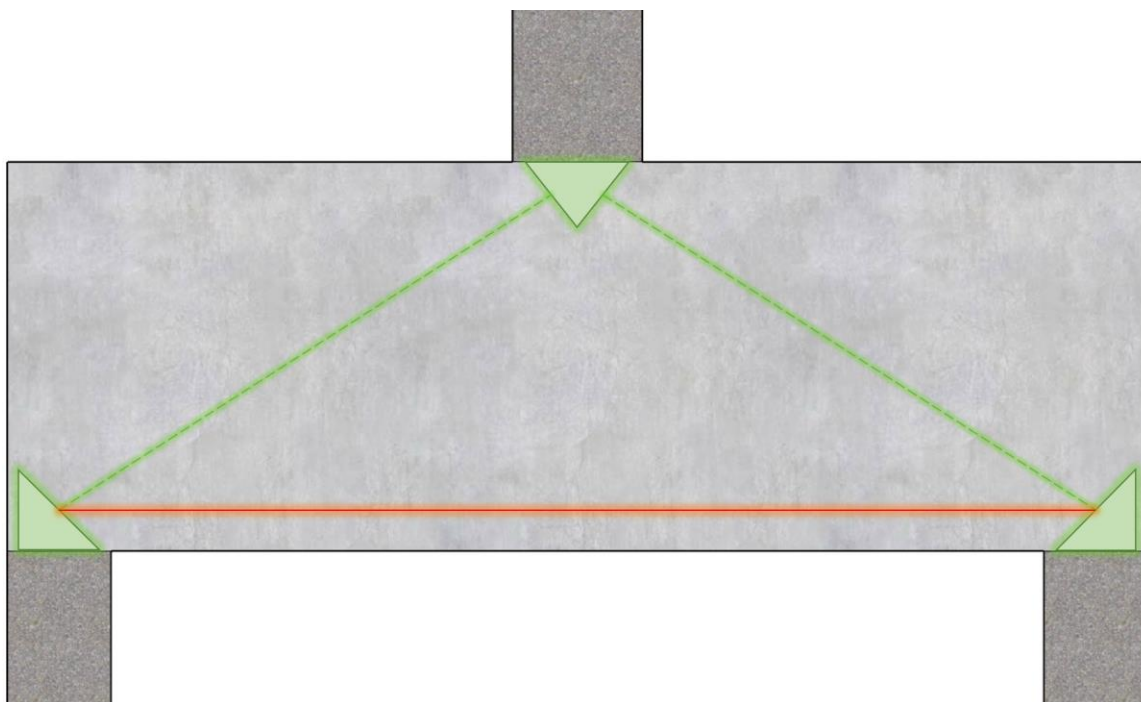
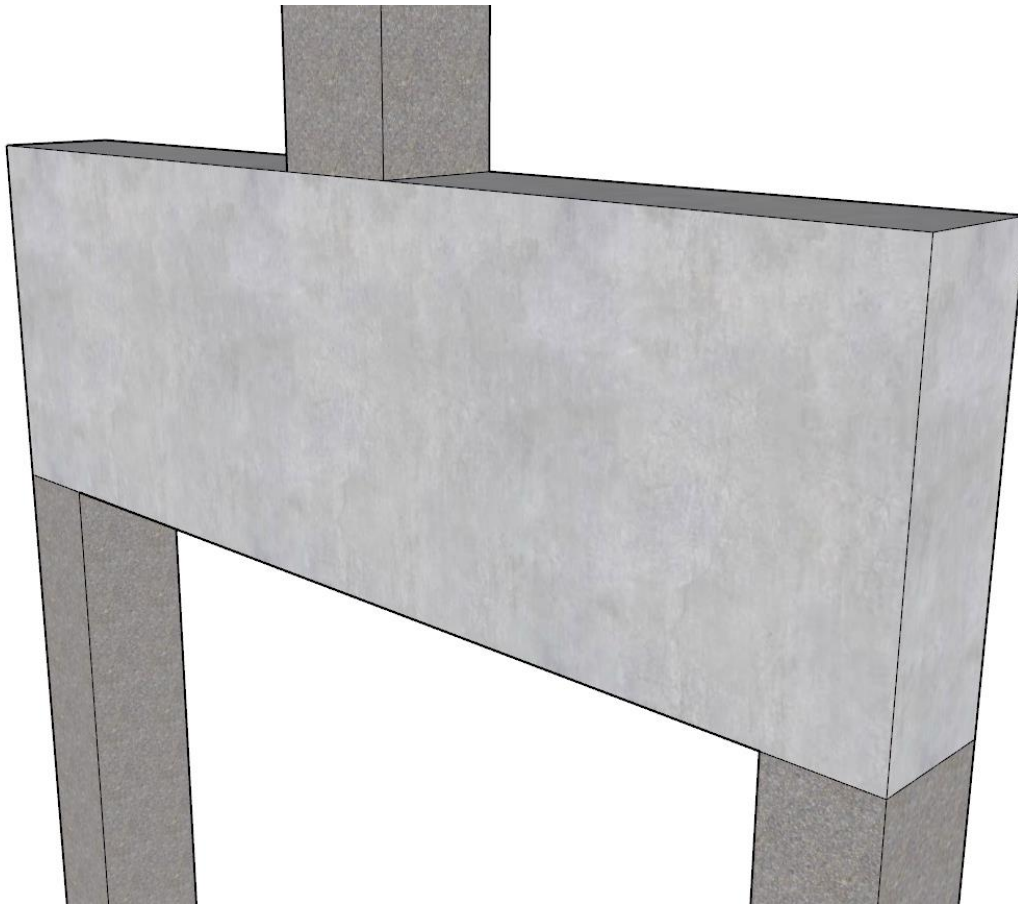

Design of Deep Beam (Transfer Girder) Using Strut-and-Tie Model (ACI 318-11)

Deep beams behavior is not governed by flexure only and considerations of combined shear and flexure need to be addressed to properly analyze and design deep concrete structural members. The Finite Element Methods (FEM) and the Strut-and-Tie Model (STM) are the two primary methods defined in the ACI 318 standard for deep beam analysis.

The transfer girder shown in the following figure will be designed to resist the applied gravity and live loads. The results obtained from a Strut-and-Tie Model following ACI 318 procedure, will then be compared with numerical finite element analysis results obtained from [spWall](#) engineering software program from [StructurePoint](#).

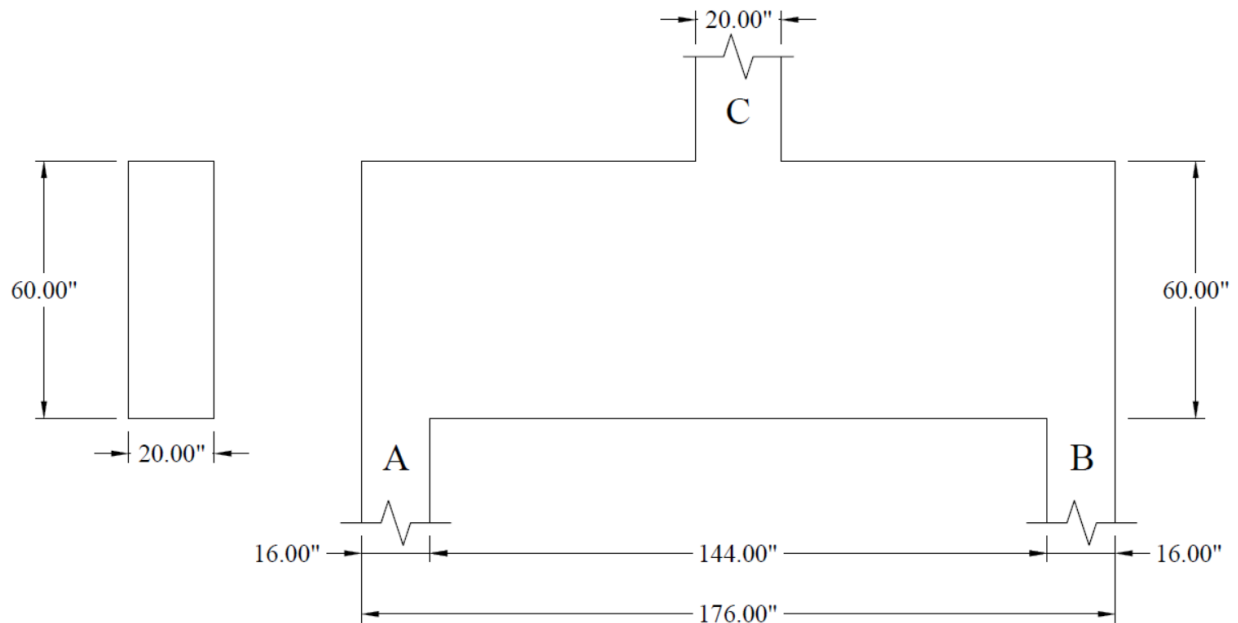

Figure 1 – Reinforced Concrete Transfer Girder (Deep Beam) Geometry

Contents

1. Method of Solution	2
1.1. STM Definitions	2
1.2. Strut-and-Tie Model Design Procedure	6
2. Solution	7
2.1. Factored Load and Reactions	7
2.2. Deep Beam Check.....	7
2.3. Maximum Shear Capacity of the Cross Section.....	7
2.4. Establish Truss Model.....	8
2.5. Effective Concrete Strength for the Struts	9
2.6. Effective Concrete Strength for the Nodal Zones	9
2.7. Strength and Truss Geometry Checks for the STM Nodal Zones	10
2.8. Vertical and Horizontal Reinforcement to Resist Splitting of STM Diagonal Struts.....	12
2.9. Horizontal Reinforcement to for Tie Connecting Nodes A and B	13
3. Deep Beam (Transfer Girder) Analysis – spWall Software	17
4. Comments, Observations and Conclusions	24

Code

Building Code Requirements for Structural Concrete (ACI 318-11) and Commentary (ACI 318R-11)

References

Notes on ACI 318-11 Building Code Requirements for Structural Concrete, Twelfth Edition, 2013 Portland Cement Association, Example 17.1

Schlaich, J.; Schafer, K. and Jennewein, M, "Toward a Consistent Design of Structural Concrete," PCI Journal, V. 32, No. 3, May-June 1987, pp. 74-150.

Collins, M.P. and Mitchell, D., "A Rational Approach to Shear Design—The 1984 Canadian Code Provisions," ACI Journal, Vol. 83, No. 6, November-December 1986, pp. 925-933.

Marti P., "Truss Models in Detailing," Concrete International, ACI, Dec. 1985, pp. 66-73.

Collins, M.P. and Mitchell, D., Prestressed Concrete Structures, Prentice Hall Inc. Englewood Cliffs, N.J., 1991, 766 pp.

MacGregor, J. G. and Wight, J.K., Reinforced Concrete Mechanics and Design, 4th Edition, Prentice Hall, Upper Saddle River, N.J., 2005, 1132 pp.

"Examples for the Design of Structural Concrete with Strut-and-Tie Models," SP-208, American Concrete Institute, Farmington Hills, MI, 2002, 242 pp.

[spWall](#) Engineering Software Program Manual v5.01, STRUCTUREPOINT, 2016

Design Data

$f_c' = 4000$ psi normal weight concrete

$f_y = 60000$ psi

The single column at midspan subjects the girder to:

DL = 180 kips

LL = 250 kips

1. Method of Solution

The Strut-and-Tie Model (STM) is a tool for the analysis, design, and detailing of reinforced concrete members. It is essentially a truss analogy, based on the fact that concrete is strong in compression, and that steel is strong in tension. Truss members that are in compression are made up of concrete, while truss members that are in tension consist of steel reinforcement.

Appendix A, Strut-and-Tie Models, was introduced in ACI 318-02. The method presented in Appendix A provides a design approach, applicable to an array of design problems that do not have an explicit design solution in the body of the code. This method requires the designer to consciously select a realistic load path within the structural member in the form of an idealized truss. Rational detailing of the truss elements and compliance with equilibrium assures the safe transfer of loads to the supports or to other regions designed by conventional procedures. While solutions provided with this powerful analysis and design tool are not unique, they represent a conservative lower bound approach. As opposed to some of the prescriptive formulations in the body of ACI 318, the very visual, rational strut-and-tie model of Appendix A gives insight into detailing needs of irregular (load or geometric discontinuities) regions of concrete structures and promotes ductility at the strength limit stage. The only serviceability provisions in the current Appendix A are the crack control reinforcement for the struts.

The design methodology presented in Appendix A is largely based on the seminal articles on the subject by Schlaich et al., Collins and Mitchell, and Marti. Since publication of these papers, the strut-and-tie method has received increased attention by researchers and textbook writers (Collins and Mitchell, MacGregor and Wight). MacGregor described the background of STM provisions incorporated in ACI 318 Appendix A in ACI Special Publication SP-208.

1.1. STM Definitions

1. B-regions represent portions of a member in which the “plane section” assumptions of the classical beam theory can be applied with a sectional design approach.
2. D-regions are all the zones outside the B-regions where cross-sectional planes do not remain plane upon loading. D-regions are typically assumed at portions of a member where discontinuities (or disturbances) of stress distribution occur due to concentrated forces (loads or reactions) or abrupt changes of geometry.

Based on St. Venant’s Principle, the normal stresses (due to axial load and bending) approach quasi-linear distribution at a distance approximately equal to the larger of the overall height (h) and width of the member, away from the location of the concentrated force or geometric irregularity. The following figure illustrates typical discontinuities, D-Regions (cross-hatched areas), and B-Regions.

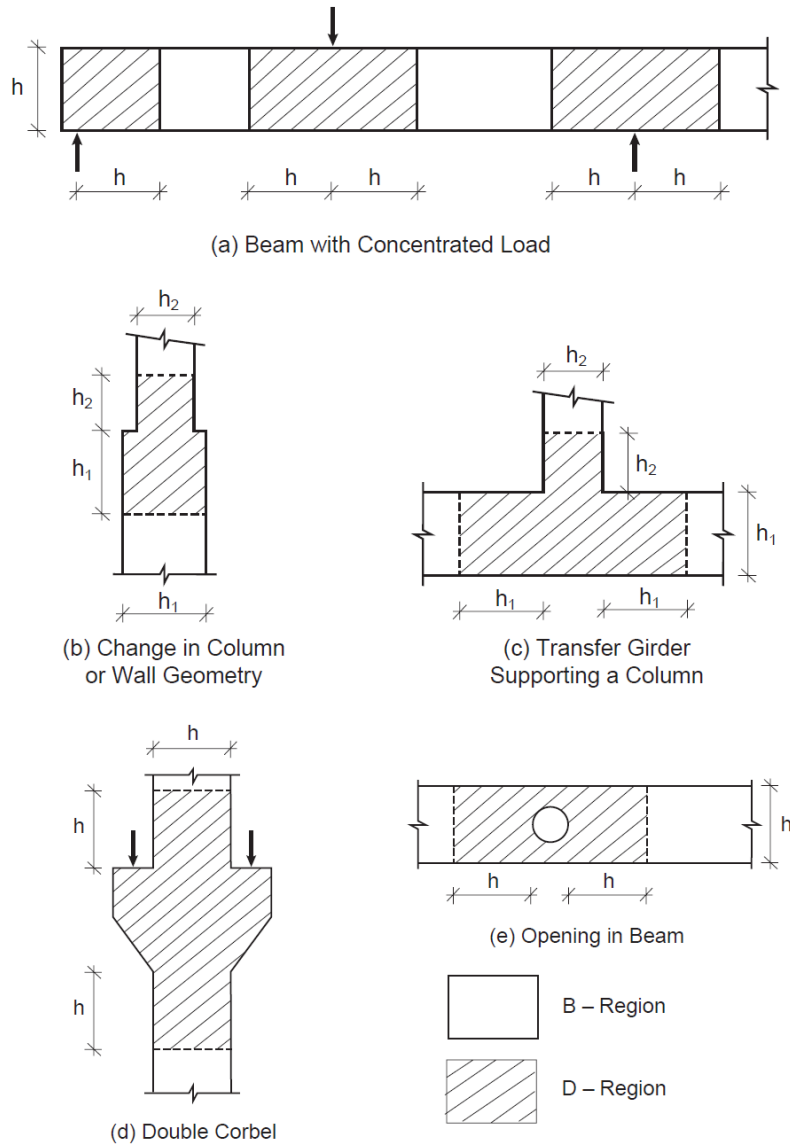

Figure 2 – Load and Geometric Discontinuities

While B-regions can be designed with the traditional methods using applicable provisions from ACI 318, the strut and-tie model was primarily introduced to facilitate the design of D-regions, and can be extended to the B-regions as well. The strut-and-tie model depicts the D-region of the structural member with a truss system consisting of compression struts and tension ties connected at nodes as shown in the following figure. This truss system is designed to transfer the factored loads to the supports or to adjacent B-regions. At the same time, forces in the truss members should maintain equilibrium with the applied loads and reactions.

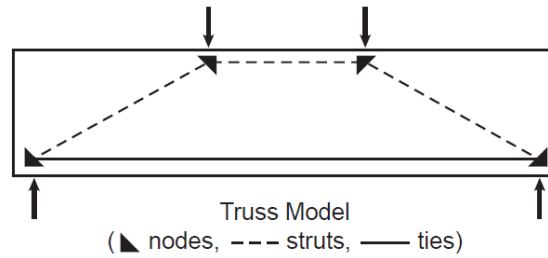
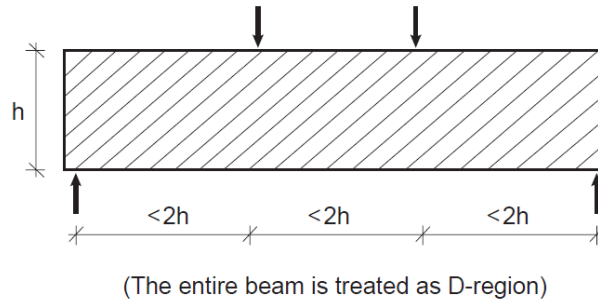

Figure 3 – Strut-and-Tie Model (STM)

- Struts** are the compression elements of the strut-and-tie model representing the resultants of a compression field. Both parallel and fan shaped compression fields can be modeled by their resultant compression struts as shown in the following figure.

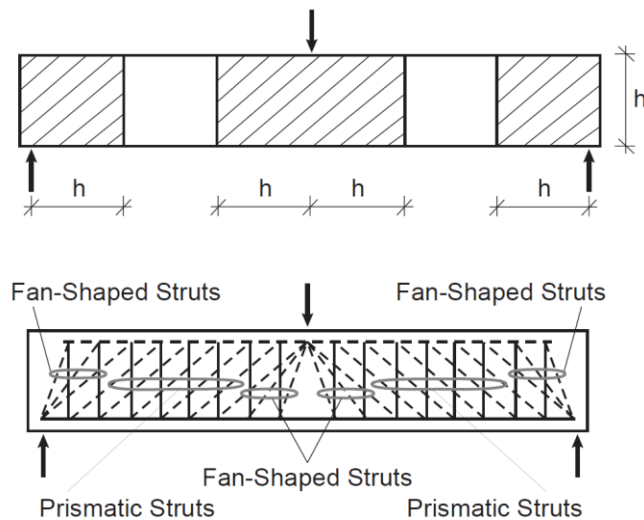

Figure 4 – Strut-and-Tie Model

- Ties** consist of conventional deformed reinforcing steel, prestressing steel, or both, plus a portion of the surrounding concrete that is concentric with the axis of the tie. The surrounding concrete is not considered to resist axial force in the model. However, it reduces the elongation of the tie (tension stiffening), in particular, under service loads. It also defines the zone in which the forces in the struts and ties are to be anchored.

5. Nodes are the intersection points of the axes of the struts, ties and concentrated forces, representing the joints of a strut-and-tie model. To maintain equilibrium, at least three forces should act on a given node of the model. Nodes are classified depending on the sign of the forces acting upon them (e.g., a C-C-C node resists three compression forces, a C-T-T node resists one compression forces and two tensile forces, etc.) as shown in following figure.



Figure 5 – Classification of Nodes

6. A nodal zone is the volume of concrete that is assumed to transfer strut and tie forces through the node. The early strut-and-tie models used hydrostatic nodal zones, which were lately superseded by extended nodal zones.
- a. The faces of a hydrostatic nodal zone are perpendicular to the axes of the struts and ties acting on the node, as depicted in the following figure. The term hydrostatic refers to the fact that the in-plane stresses are the same in all directions. (Note that in a true hydrostatic stress state the out-of-plane stresses should be also equal). Assuming identical stresses on all faces of a C-C-C nodal zone with three struts implies that the ratios of the lengths of the sides of the nodal zones ($w_{n1} : w_{n2} : w_{n3}$) are proportional to the magnitude of the strut forces ($C_1 : C_2 : C_3$). Note, that C denotes compression and T denotes tension.

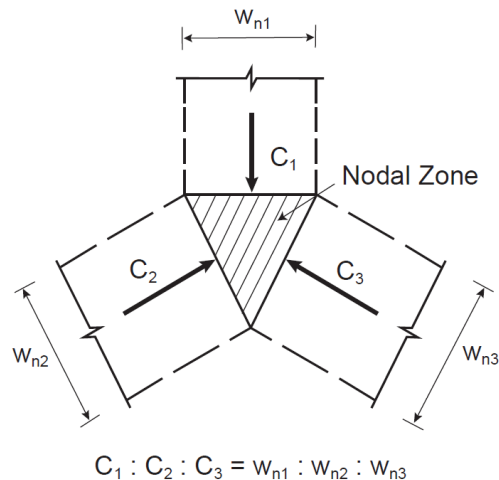

Figure 6 – Hydrostatic Nodal Zone

- b. The extended nodal zone is a portion of a member bounded by the intersection of the effective strut width, w_s , and the effective tie width, w_t . This is illustrated in following figure.

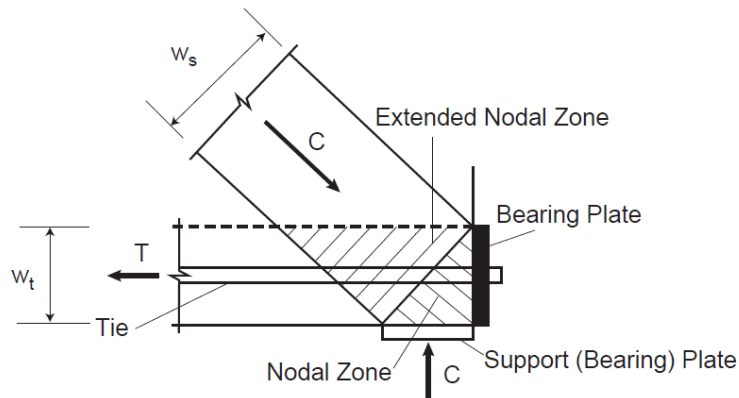

Figure 7 – Extended Nodal Zone

1.2. Strut-and-Tie Model Design Procedure

A design with the strut-and-tie model typically involves the following steps:

1. Define and isolate D-regions.
2. Compute resultant forces on each D-region boundary.
3. Devise a truss model to transfer the resultant forces across the D-region. The axes of the struts and ties, are oriented to approximately coincide with the axes of the compression and tension stress fields respectively.
4. Calculate forces in the truss members using hand calculations, analysis aid tables, or structural analysis software based on the complexity of the selected truss model - STM.
5. Determine the effective widths of the struts and nodal zones considering the forces from the previous steps and the effective concrete strengths (defined in A.3.2 and A.5.2).
6. Provide reinforcement for the ties considering the steel strengths defined in A.4.1. The reinforcement must be detailed to provide proper anchorage either side of the critical sections. In addition to the strength limit states, represented by the strut-and-tie model, structural members should be checked for serviceability requirements. Traditional elastic analysis can be used for deflection checks. Crack control can be verified using provisions of 10.6.4, assuming that the tie is encased in a prism of concrete corresponding to the area of tie (RA.4.2).

2. Solution

2.1. Factored Load and Reactions

Girder Self-Weight: $P_{SW} = 150 \times \left[\frac{20}{12} \times \frac{60}{12} \times 15 \right] \times \frac{1}{1000} = 18.75 \text{ kip}$

Dead Load: $P_{DL} = 180 \text{ kip}$

Live Load: $P_{LL} = 250 \text{ kip}$

Factored Load $P_u = 1.2 \times (P_{SW} + P_{DL}) + 1.6 \times P_{LL}$ ACI 318-11 (Eq. 9-2)

$$P_u = 1.2 \times (18.75 + 180) + 1.6 \times 250 = 638.5 \text{ kips (at point C)}$$

Reactions $R_{u,A} = R_{u,A} = \frac{P_u}{2} = \frac{638.5}{2} = 319.3 \text{ kips}$

2.2. Deep Beam Check

The beam is considered deep if $\frac{l_n}{h} < 4$ ACI 318-11 (10.7.1 & 11.7.1)

$$\frac{l_n}{h} = \frac{12 \times 12}{60} = 2.4 < 4 \quad \therefore \text{the beam is considered as deep beam.}$$

2.3. Maximum Shear Capacity of the Cross Section

$$V_u = R_{u,A} = 319.3 \text{ kips}$$

$$\phi V_n = \phi \times 10 \times \lambda \times \sqrt{f'_c} \times b_w \times d$$
 ACI 318-11 (11.7.3 & 10.7.2)

$$\phi V_n = 0.75 \times 10 \times 1 \times \sqrt{4000} \times 20 \times (0.9 \times 60) = 512.3 \text{ kips} > V_u \quad \text{O.K.}$$

2.4. Establish Truss Model

Several strut-and-tie models can be selected. The following model is being selected in order to be consistent with the reference. Alternative truss or STMs are discussed later in this document.

Assume that the nodes coincide with the centerline of the column and supports, and are located 5 in. from the upper or lower edge of the beam as shown in the following figure. This strut-and-tie model consists of two struts (A-C and B-C), one tie (A-B), and three nodes (A, B, and C). In addition, columns at A and B act as struts representing reactions. The vertical strut located in the upper column at the top of Node C represents the applied load.

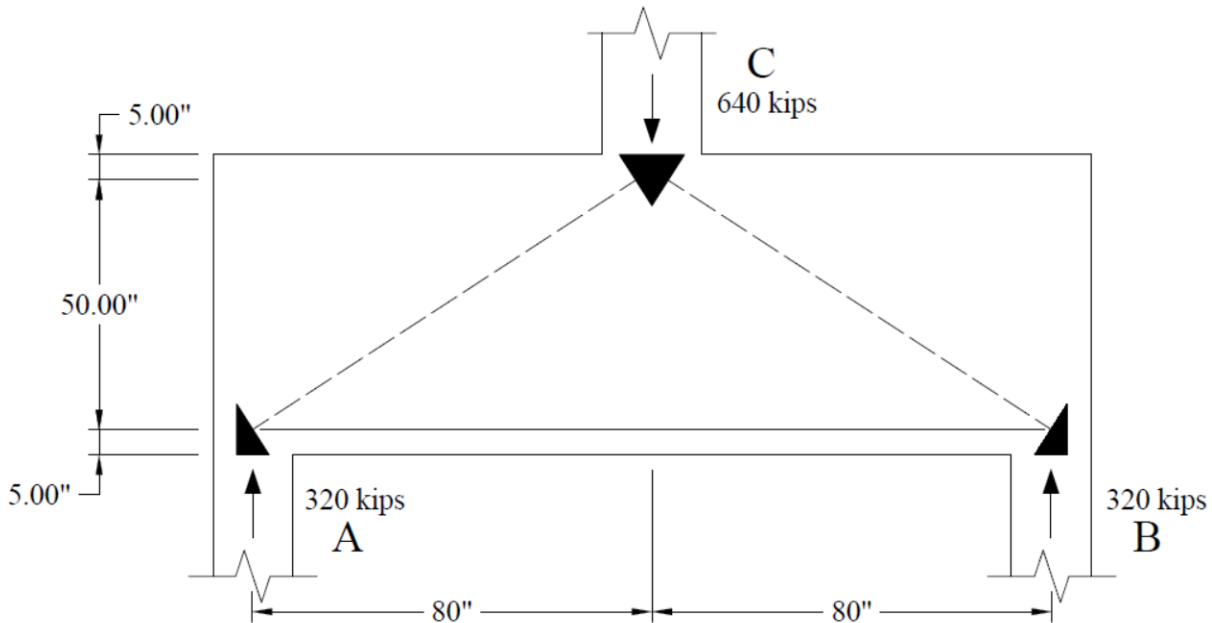

Figure 8 – Preliminary Truss Model Layout

Length of diagonal struts: $L_{AC} = L_{BC} = \sqrt{50^2 + 80^2} = 94.3 \text{ in.}$

Length of the horizontal tie: $L_{AB} = 80 + 80 = 160 \text{ in.}$

The force in diagonal struts: $F_{AC} = F_{BC} = 320 \times \frac{94.3}{50} = 603 \text{ kips}$

The force in horizontal tie: $F_{AB} = 320 \times \frac{80}{50} = 512 \text{ kips}$

The angle between the diagonal struts and horizontal tie:

$$\alpha = \tan^{-1}\left(\frac{50}{80}\right) = 32^\circ > 25^\circ \quad \underline{\underline{O.K.}} \quad \underline{\underline{ACI 318-11 (A.2.5)}}$$

2.5. Effective Concrete Strength for the Struts

The effective concrete strength for the struts in this STM is calculated assuming that reinforcement is provided per to resist splitting forces. ACI 318-11 (A.3.3)

For the “bottle-shaped” struts A-C and B-C:

$$(f_{ce})_{AC} = (f_{ce})_{BC} = 0.85 \times \beta_s \times f'_c = 0.85 \times 0.75 \times 4000 = 2550 \text{ psi} \quad \text{ACI 318-11 (Eq. A-3)}$$

Where:

$$\beta_s = 0.75 \quad \text{ACI 318-11 (A.3.2.2(a))}$$

This effective compressive strength cannot exceed the strength of the nodes at both ends of the strut.

ACI 318-11 (A.3.1)

The vertical struts in columns A, B, and C can be assumed to have uniform cross-sectional area throughout their length.

$$(f_{ce})_A = (f_{ce})_B = (f_{ce})_C = 0.85 \times \beta_s \times f'_c = 0.85 \times 1.0 \times 4000 = 3400 \text{ psi} \quad \text{ACI 318-11 (Eq. A-3)}$$

Where:

$$\beta_s = 1.0 \text{ for prismatic struts} \quad \text{ACI 318-11 (A.3.2.1)}$$

2.6. Effective Concrete Strength for the Nodal Zones

Nodal Zone C is bounded by three struts. Thus, this is a C-C-C nodal zone where:

$$\beta_n = 1.0 \quad \text{ACI 318-11 (A.5.2.1)}$$

$$(f_{ce})_{Node C} = 0.85 \times \beta_n \times f'_c = 0.85 \times 1.0 \times 4000 = 3400 \text{ psi} \quad \text{ACI 318-11 (Eq. A-8)}$$

Nodal Zones A and B are bounded by two struts and a tie. Thus, this is a C-C-T nodal zone where:

$$\beta_n = 0.80 \quad \text{ACI 318-11 (A.5.2.2)}$$

$$(f_{ce})_{Node C} = 0.85 \times \beta_n \times f'_c = 0.85 \times 0.8 \times 4000 = 2720 \text{ psi} \quad \text{ACI 318-11 (Eq. A-8)}$$

2.7. Strength and Truss Geometry Checks for the STM Nodal Zones

Node C:

Assume that a hydrostatic nodal zone is formed at Node C. This means that the faces of the nodal zone are perpendicular to the axis of the respective struts, and that the stresses are identical on all faces.

To satisfy the strength criteria for all three struts and the node, the minimum nodal face dimension is determined based on the least strength value:

$$f_{ce} = \min \left\{ \begin{array}{l} (f_{ce})_{AC} = (f_{ce})_{BC} \\ (f_{ce})_C \\ (f_{ce})_{Node\ C} \end{array} \right\} = \min \left\{ \begin{array}{l} 2550 \\ 3400 \\ 2720 \end{array} \right\} = 2550 \text{ psi}$$

Thus, governed by the bottle-shaped diagonal struts. The same strength value will be used for Nodes A and B as well.

The strength checks for all components of the strut and tie model are based on

$$\phi F_n \geq F_u$$

ACI 318-11 (Eq. A-1)

Where:

$$\phi = 0.75$$

ACI 318-11 (9.3.2.6)

The length of the horizontal face of Nodal Zone C is calculated as:

$$L_{Horizontal,C} = \frac{P_u}{\phi \times f_{ce} \times b} = \frac{640000}{0.75 \times 2550 \times 20} = 16.7 \text{ in.}$$

Notice that the horizontal face of Nodal Zone C is less than the column width (20 in.).

The length of the other faces, perpendicular to the diagonal struts, can be obtained from proportionality:

$$L_{Diagonal,C} = L_{Horizontal,C} \times \frac{F_{AC}}{P_u} = 16.7 \times \frac{603}{640} = 15.7 \text{ in.}$$

The center of the nodal zone is at 4.0 in. from the top of the beam (as shown in the following figure), which is very close to the assumed 5 in.

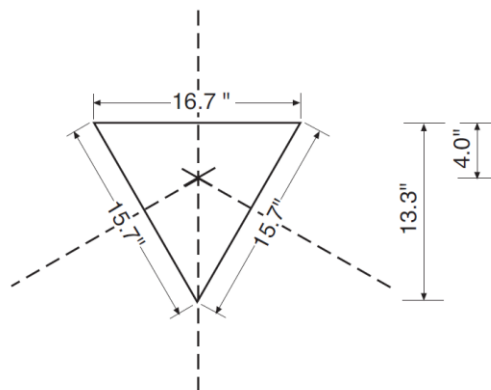

Figure 9 – Geometry of Node C

Nodes A and B:

The same strength value used for node C will be used for Nodes A and B as well.

$$f_{ce} = 2550 \text{ psi}$$

The length of the vertical face of Nodal Zone A and B is calculated as:

$$L_{\text{Vertical},A} = \frac{F_{AB}}{\phi \times f_{ce} \times b} = \frac{512000}{0.75 \times 2550 \times 20} = 13.4 \text{ in.}$$

The center of the tie is located $13.4/2 = 6.7$ in. from the bottom of the beam.

This is reasonably close to the 5 in. originally assumed, so no further iteration is warranted.

The length of the horizontal face of Nodal Zone A and B:

$$L_{\text{Horizontal},A} = \frac{R_{u,A}}{\phi \times f_{ce} \times b} = \frac{320000}{0.75 \times 2550 \times 20} = 8.4 \text{ in.}$$

The following figure shows the geometry of Nodes A based on the calculations shown above (note that the geometry of Node B is identical to Node A).

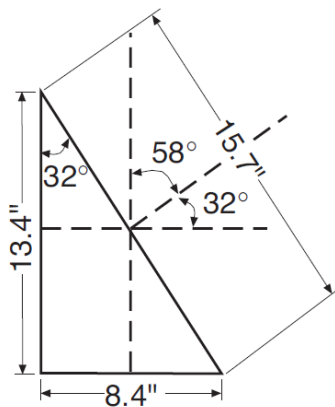

Figure 10 – Geometry of Node C

2.8. Vertical and Horizontal Reinforcement to Resist Splitting of STM Diagonal Struts

For f_c' not greater than 6000 psi, the requirement of ACI 318-11 (A.3.3) shall be permitted to be satisfied by the axis of the strut being crossed by layers of reinforcement that satisfy ACI 318-11 (Eq. A-4).

$$f_c' = 4000 \text{ psi} \leq 6000 \text{ psi} \quad \text{O.K.} \quad \text{ACI 318-11 (9.3.2.6)}$$

The angle between the vertical ties and the struts (α_2 is calculated in section 2.4):

$$\alpha_1 = 90^\circ - \alpha_2 = 90^\circ - 32^\circ = 58^\circ \quad \text{ACI 318-11 (RA.3.3)}$$

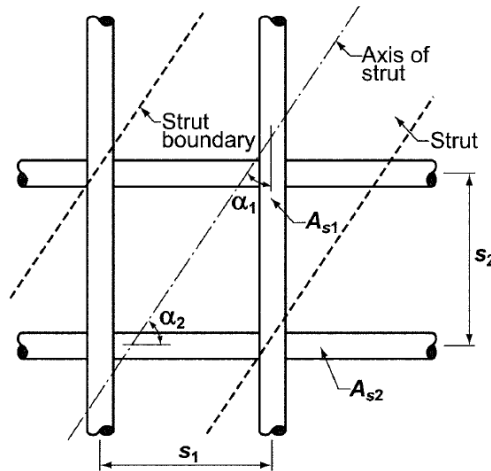

Figure 11 – Reinforcement Crossing a Strut (ACI 318-11)

For vertical reinforcement, try two overlapping #4 stirrups @ 11 in. o.c. to accommodate the longitudinal tie reinforcement designed in the next section.

For horizontal reinforcement, try #5 horizontal bars @ 11 in. o.c. on each side face.

The 11 in. spacing is calculated as follows:

$$s_{req} = \min \left\{ \frac{d}{5} \right\} = \min \left\{ \frac{54}{5} \right\} = \min \left\{ \begin{matrix} 10.8 \text{ in.} \\ 12 \text{ in.} \end{matrix} \right\} = 10.8 \text{ in.} \quad \text{ACI 318-11 (11.7.4.1)}$$

Based on the selected reinforcement:

$$\sum \left(\frac{A_{st}}{b_s \times S_i} \times \sin \alpha_i \right) \geq 0.003 \quad \text{ACI 318-11 (Eq. A-4)}$$

$$\frac{4 \times 0.20}{20 \times 11} \times \sin 58^\circ + \frac{2 \times 0.31}{20 \times 11} \times \sin 32^\circ = 0.00309 + 0.00149 = 0.0046 > 0.003 \quad \text{O.K.}$$

Both directions of shear reinforcement have to satisfy deep beams requirements for this transfer girder as shown below:

$$A_{sv} \geq 0.0025 \times b \times s \quad \text{ACI 318-11 (11.7.4.1)}$$

$$A_{sv} = 0.80 \text{ in.}^2 \geq 0.0025 \times 20 \times 11 = 0.55 \text{ in.}^2 \quad \text{O.K.}$$

$$A_{sh} \geq 0.0025 \times b \times s \quad \text{ACI 318-11 (11.7.4.2)}$$

$$A_{sh} = 0.62 \text{ in.}^2 \geq 0.0025 \times 20 \times 11 = 0.55 \text{ in.}^2 \quad \text{O.K.}$$

2.9. Horizontal Reinforcement to for Tie Connecting Nodes A and B

$$A_{s,req} = \frac{F_u}{\phi f_y} = \frac{F_{AB}}{\phi f_y} = \frac{512}{0.75 \times 60} = 11.4 \text{ in.}^2 \quad \rightarrow \quad \text{Select 16 \#8 (} A_s = 12.64 \text{ in.}^2 \text{)}$$

These bars must be properly anchored. The anchorage length (l_{anc}) is to be measured from the point where the tie exits the extended nodal zone as shown in the following figure:

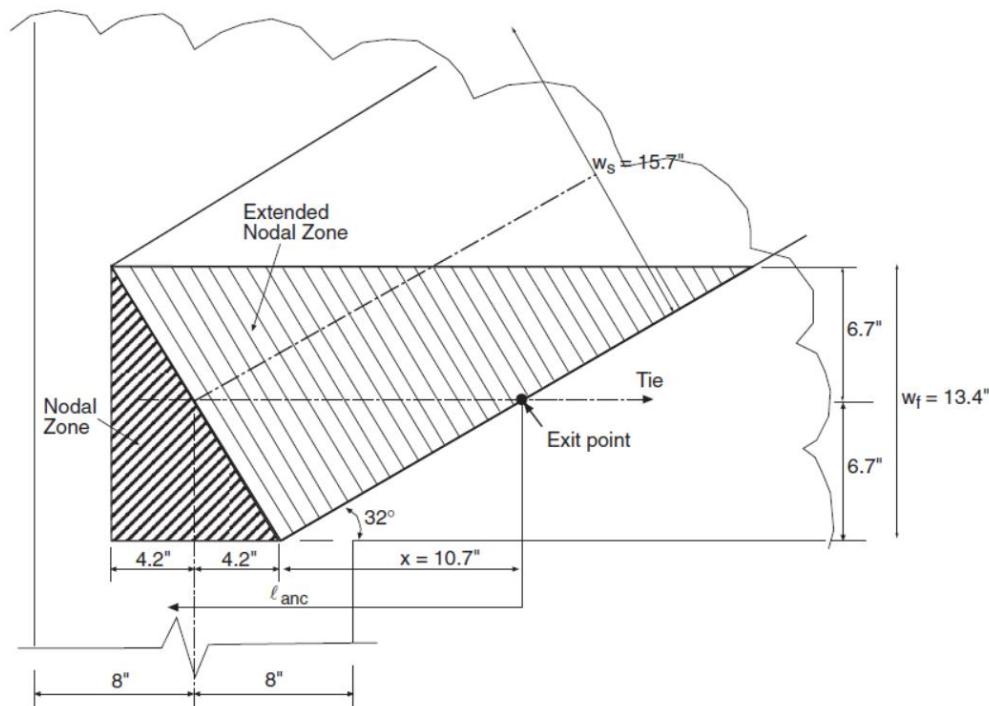

Figure 12 – Development of Tie Reinforcement Within the Extended Nodal Zone

$$x = \frac{L_{Vertical,A} / 2}{\tan(\alpha_2)} = \frac{13.4 / 2}{\tan(32^\circ)} = 10.7 \text{ in.}$$

$$(l_{dh})_{available} = x + \frac{L_{Horizontal,A}}{2} + \frac{Bearing}{2} = 10.7 + \frac{8.3}{2} + \frac{16}{2} = 20.9 \text{ in.}$$

Required development length for straight bars in tension can be estimated using the following equation:

$$(l_{dh})_{required} = 47 \times d_b = 47 \text{ in.} > (l_{dh})_{available} = 20.9 \text{ in.} \quad \underline{\text{N.G.}} \quad \underline{\text{ACI 318-11 (R12.2)}}$$

Use #8 bars with a standard 90° hook:

$$(l_{dh})_{required} = \left(\frac{0.02 \times \Psi_e \times f_y}{\lambda \times \sqrt{f'_c}} \right) \times d_b \quad \underline{\text{ACI 318-11 (12.5.2)}}$$

$$(l_{dh})_{required} = \left(\frac{0.02 \times 1 \times 60000}{1 \times \sqrt{4000}} \right) \times 1.0 = 19 \text{ in.} < (l_{dh})_{required} = 20.9 \text{ in.} \quad \underline{\text{O.K.}}$$

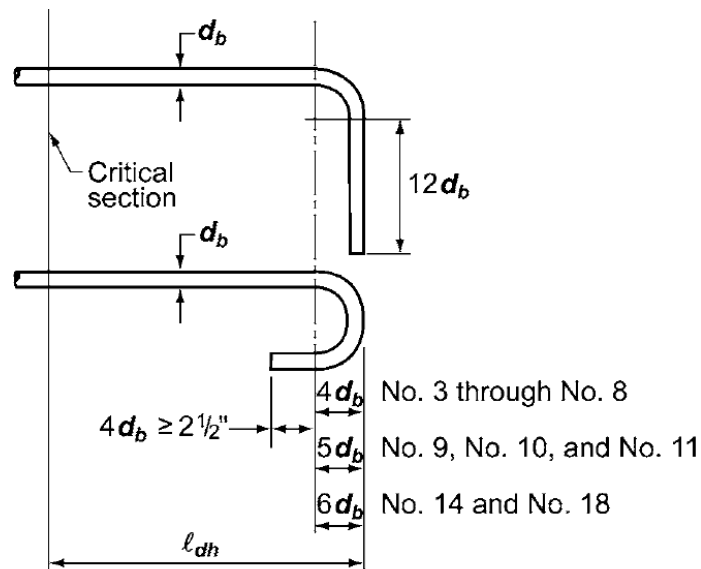

Figure 13 – Hooked Bar Details for Development of Standard Hooks (ACI 318-11)

The following are notes related to the development length of the horizontal reinforcement for the tie:

- 1) the 90° hooks will be enclosed within the column reinforcement that extends in the transfer girder.
- 2) By providing adequate cover and transverse confinement, the development length of the standard hook could be reduced by modifiers. ACI 318-11 (12.5.2)
- 3) Less congested reinforcement schemes can be devised with the use of head bars, reinforcing steel welded to bearing plates, or with the use of prestressing steel. ACI 318-11 (12.6)

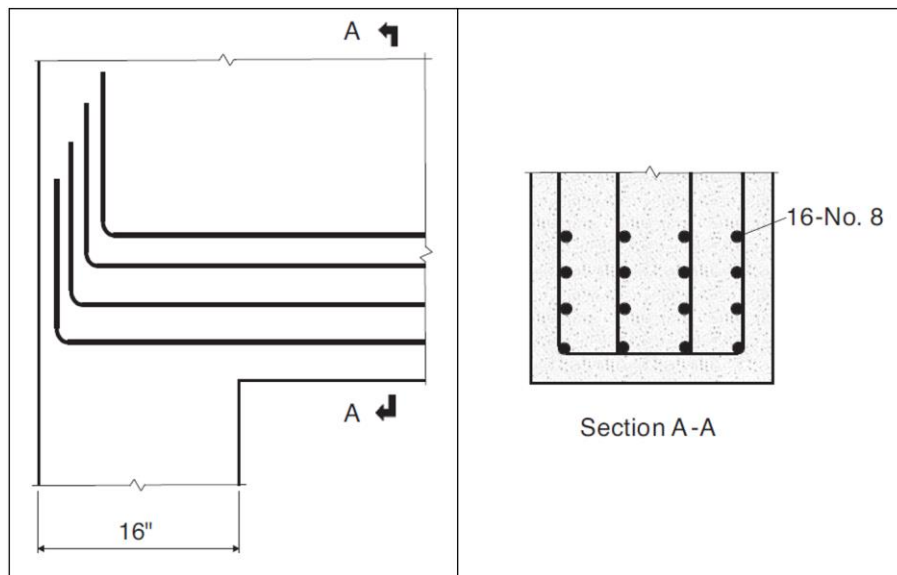

Figure 14 – Detail of STM Tie Reinforcement

The discrepancy in the vertical location of the nodes results in a negligible (about 1.5 percent) difference in the truss forces. Thus, another iteration is not warranted.

There are several alternative strut-and-tie models that could have been devised for this problem. An alternative truss layout/STM is illustrated in the following figure. It has the advantage that the force in the bottom chord varies between nodes, instead of being constant between supports. Further, the truss posts carry truss forces, instead of providing vertical reinforcement just for crack control. *ACI 318-11 (A.3.3.1)*

Finally, the diagonals are steeper, therefore the diagonal compression and the bottom chord forces are reduced. The optimum idealized truss/STM is one that requires the least amount of reinforcement.

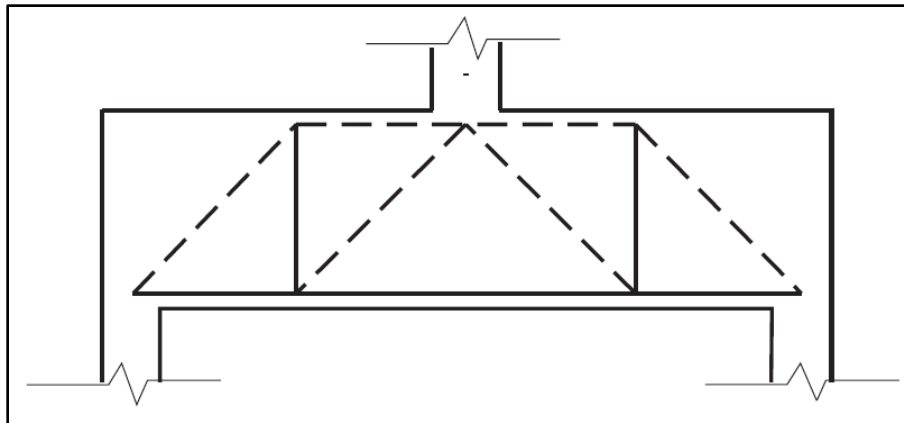

Figure 15 – Alternative Strut-and-Tie Model

3. Deep Beam (Transfer Girder) Analysis – [spWall](#) Software

[spWall](#) is a program typically used for the analysis and design of reinforced concrete shear walls, tilt-up walls, bearing and architectural precast walls. Additionally, the program can be used to analyze and design deep beams, transfer girders, coupling beams, corbels, pile caps, and other non-standard concrete elements with geometric discontinuity.

[spWall](#) uses a graphical interface that enables the user to easily generate complex models. Graphical user interface is provided for:

- Structural member geometry (including any number of openings and stiffeners)
- Material properties including cracking coefficients
- Loads (point, line, and area),
- Support conditions (including translational and rotational spring supports)

[spWall](#) uses the Finite Element Method (FEM) for the structural modeling, analysis, and design of slender and non-slender reinforced concrete members subject to static loading conditions. The member is idealized as a mesh of rectangular plate elements and straight-line stiffener elements. Members of any geometry are idealized to conform to geometry with rectangular boundaries. Plate and stiffener properties can vary from one element to another but are assumed by the program to be uniform within each element.

Six degrees of freedom exist at each node: three translations and three rotations relating to the three Cartesian axes. An external load can exist in the direction of each of the degrees of freedom. Sufficient number of nodal degrees of freedom should be restrained in order to achieve stability of the model. The program assembles the global stiffness matrix and load vectors for the finite element model. Then, it solves the equilibrium equations to obtain deflections and rotations at each node. Finally, the program calculates the internal forces and internal moments in each element. At the user's option, the program can perform second order analysis. In this case, the program takes into account the effect of in-plane forces on the out-of-plane deflection with any number of openings and stiffeners.

In [spWall](#), the required flexural reinforcement is computed based on the selected design standard (ACI 318-11 is used in this example), and the user can specify one or two layers of wall reinforcement. In stiffeners and boundary elements, [spWall](#) calculates the required shear and torsion steel reinforcement. Member concrete strength (in-plane and out-of-plane) is calculated for the applied loads and compared with the code permissible shear capacity.

For illustration and comparison purposes, the following figures provide a sample of the input modules and results obtained from an [spWall](#) model created for the reinforced concrete deep beam (transfer girder) in this example.

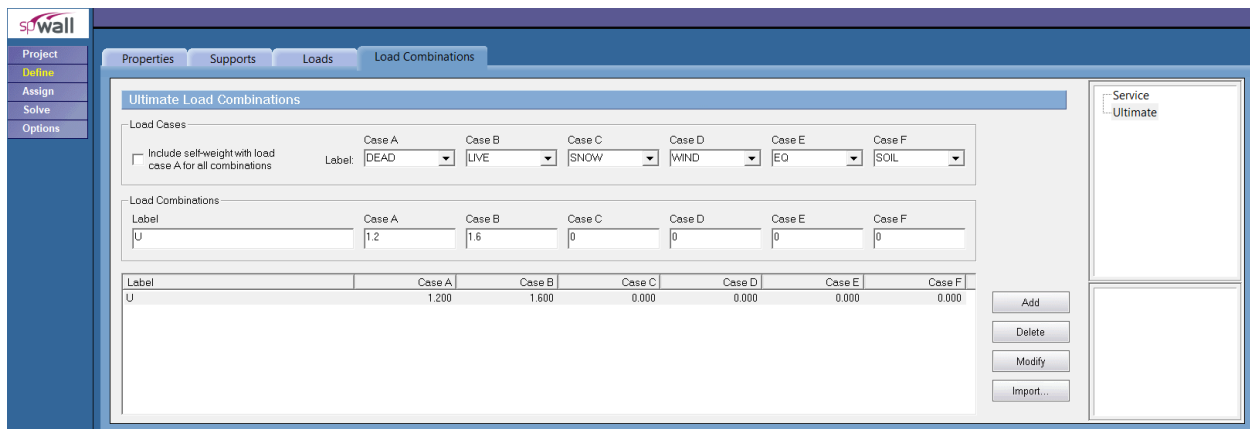
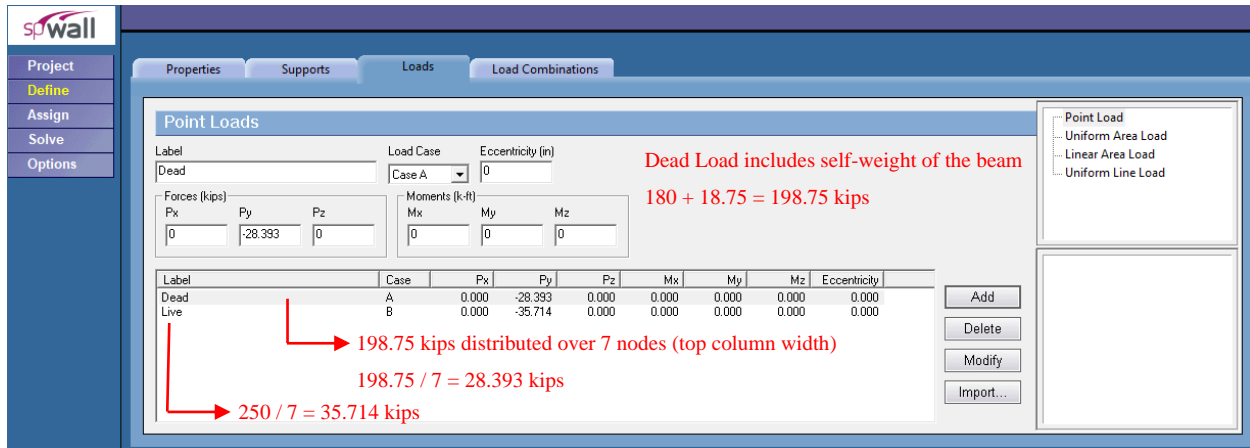

Figure 16 –Defining Loads and Load Combinations (spWall)

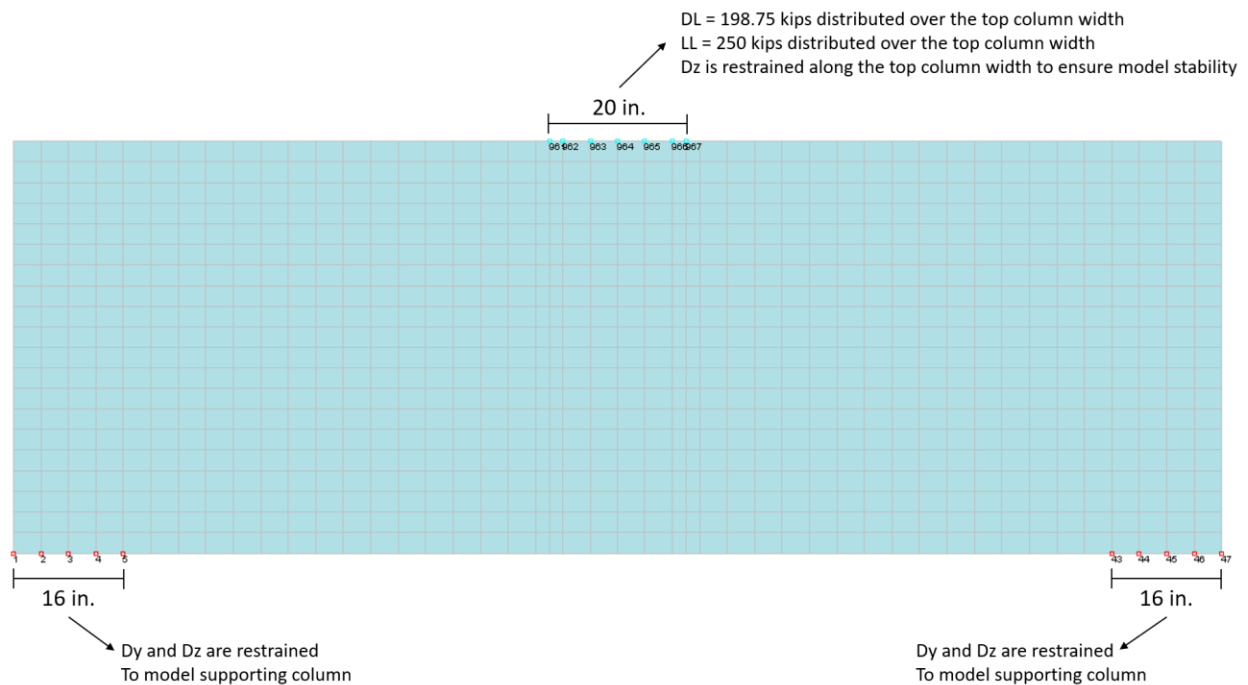

Figure 17 – Meshing & Assigning Loads and Boundary Conditions (spWall)

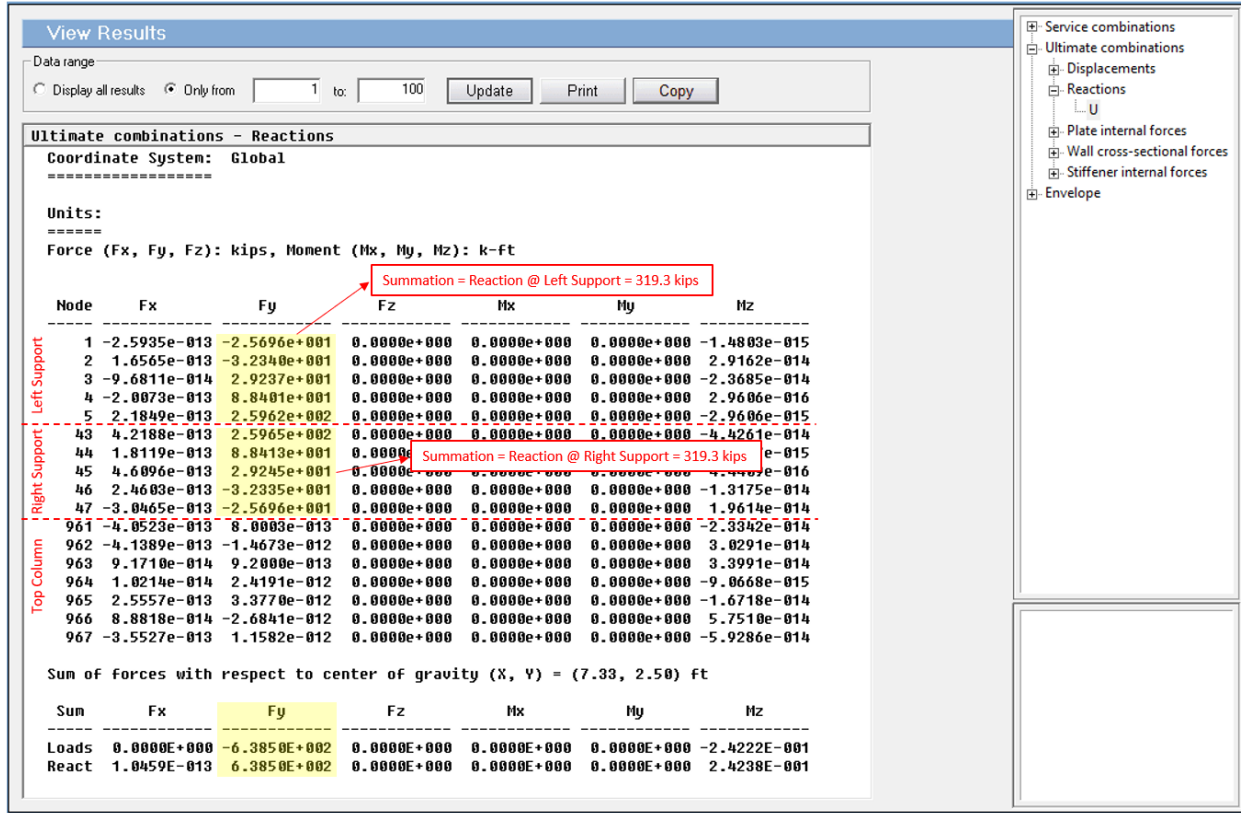

Figure 18 – Loads and Reactions (kips) (spWall)

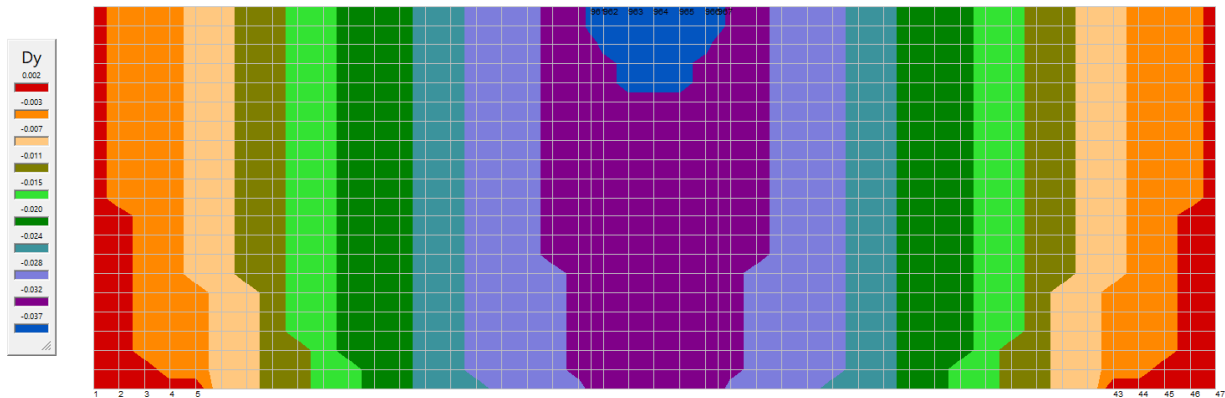

Figure 19 – Service Vertical Displacements (in.) (spWall)

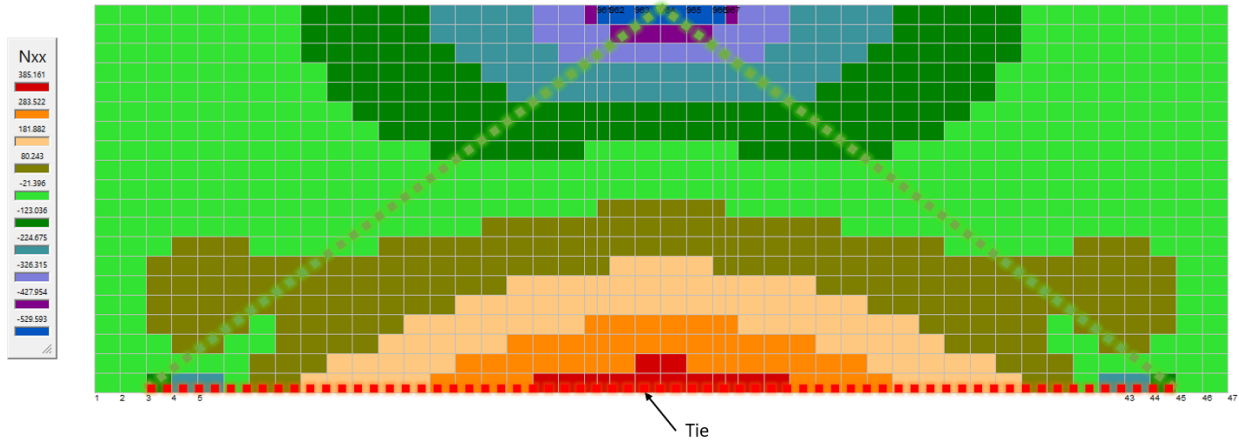

Figure 20 – Internal Axial Forces X-Direction (kips) (spWall)

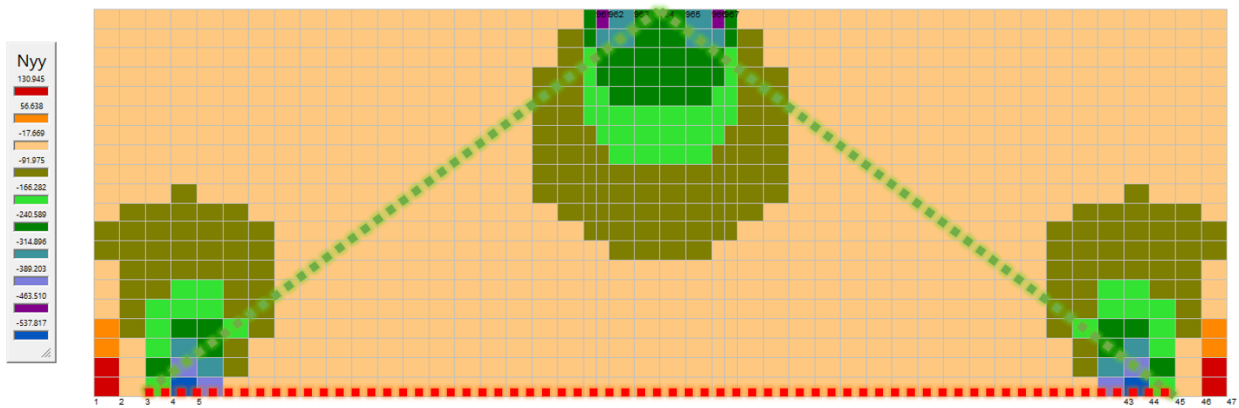

Figure 21 – Internal Axial Forces Y-Direction (kips) (spWall)

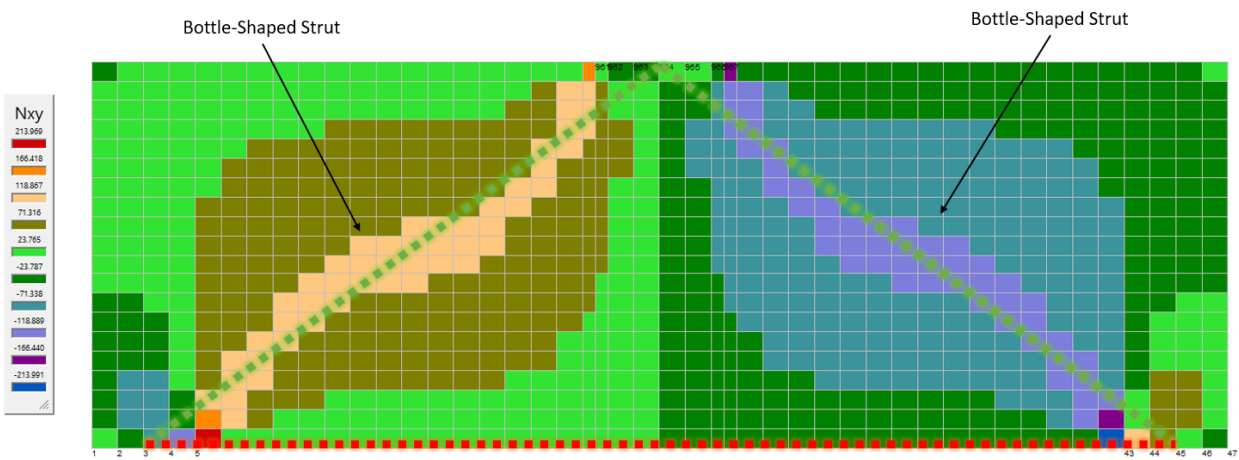

Figure 22 – Internal Shear Forces (kips) (spWall)

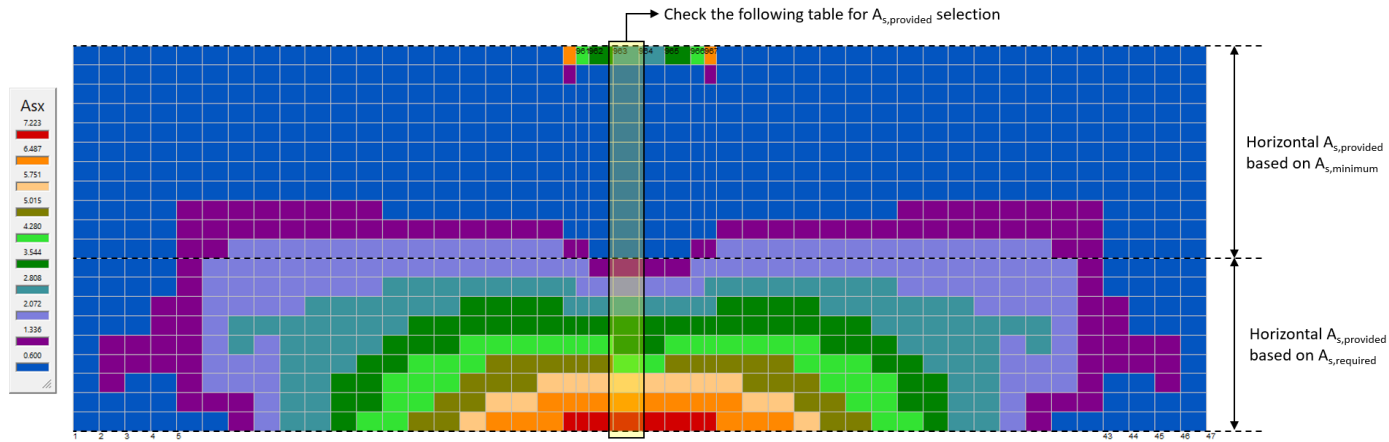
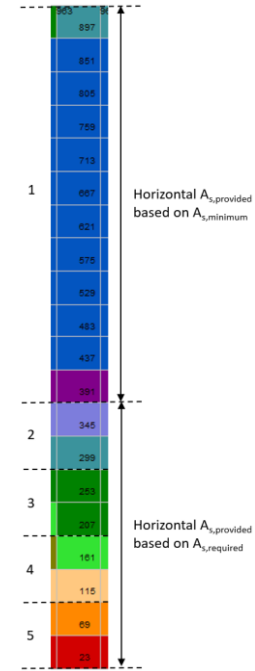

Figure 23 – Required Horizontal Reinforcement (in.²/in.) (spWall)

Table 1 - Required and Provided Horizontal Reinforcement Based on spWall Results					
Horizontal $A_{s,provided}$ based on $A_{s,min}$					
Increment	Elements	A_s , in. ² /ft	$A_{s,required}$, in. ²	Reinforcement	$A_{s,provided}$, in. ²
1	391 - 897	0.60	0.50	2#5 @ 10 in.	0.62
Horizontal $A_{s,provided}$ based on $A_{s,required}$					
Increment	Elements	A_s , in. ² /ft	$A_{s,required}$, in. ²	Reinforcement	$A_{s,provided}$, in. ²
2	345	2.56	1.12	4#5	1.24
	299	1.93			
3	253	3.90	1.78	4#7	2.40
	207	3.21			
4	161	5.43	2.52	4#8	3.16
	115	4.64			
5	69	7.22	3.38	4#9	4.00
	23	6.30			



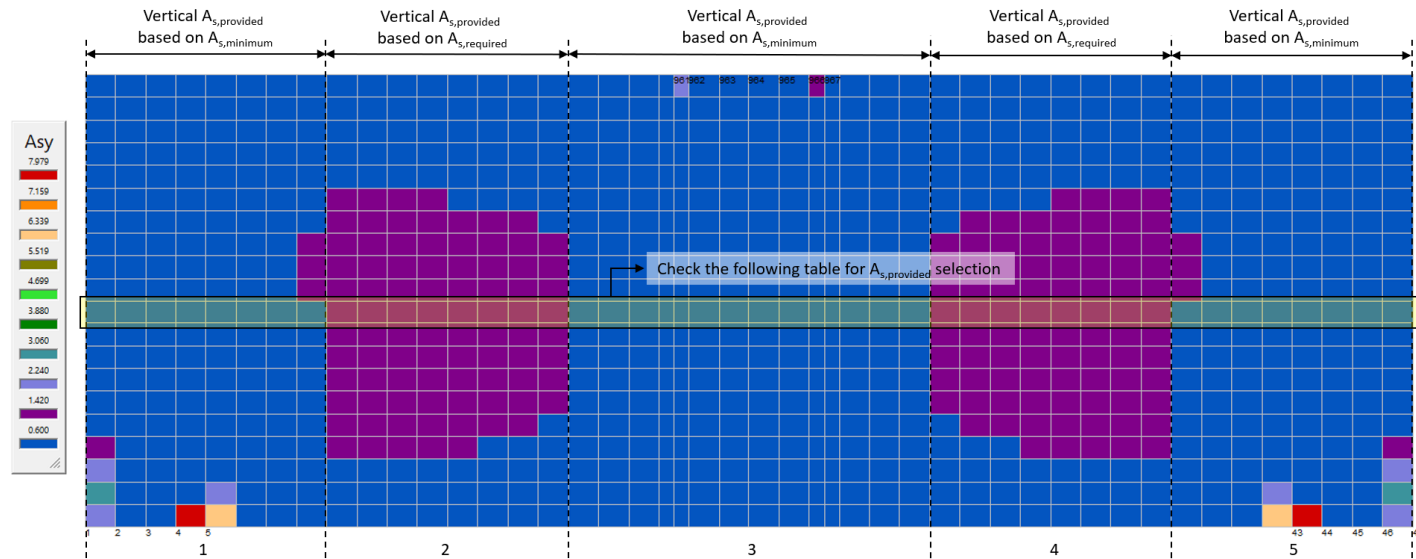
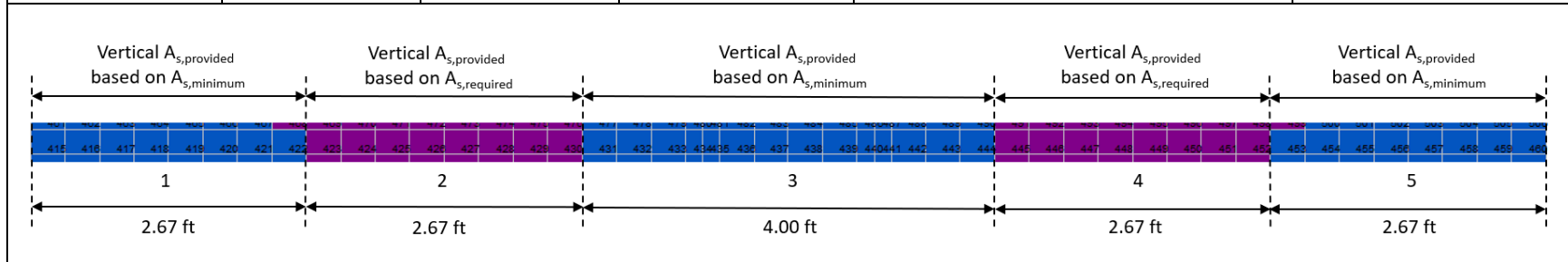

Figure 24 – Required Vertical Reinforcement (in.²/in.) (spWall)

Table 2 - Required and Provided Vertical Reinforcement Based on spWall Results

Zone	Elements	A_s , in.²/ft	$A_{s,required}$, in.²	Reinforcement	$A_{s,provided}$, in.²
1	415-422	0.60	0.50	#4 Stirrups (4 legs) @ 10 in.	0.80
2	423-430	1.68	1.40	#6 Stirrups (4 legs) @ 10 in.	1.76
3	431-444	0.60	0.50	#4 Stirrups (4 legs) @ 10 in.	0.80
4	445-452	1.68	1.40	#6 Stirrups (4 legs) @ 10 in.	1.76
5	453-460	0.60	0.50	#4 Stirrups (4 legs) @ 10 in.	0.80



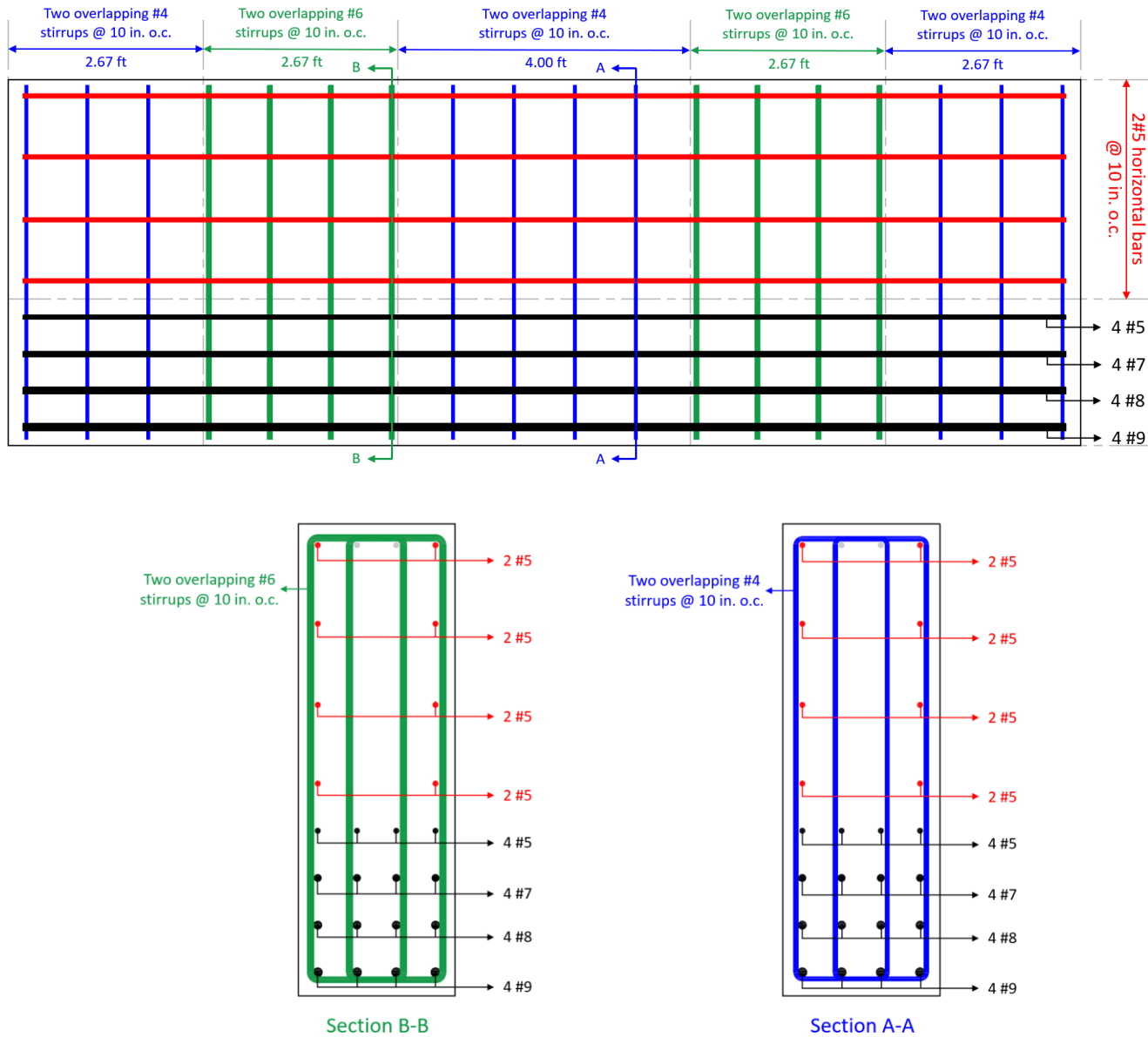

Figure 25 – Summary of Provided Reinforcement (spWall)

The previous figure shows the recommended reinforcement configuration selected for educational and illustration purposes. The provided reinforcement configuration can vary based on engineering judgement taking into account the configuration practicality, erection flexibility, number of girders, steel tonnage allowance and the project complexity. Note that the strength reduction factor used in the STM is 0.75 compared with 0.90 used in the FEM.

The STM is used to check strength limit states, however, structural members should be checked for serviceability requirements. The ACI code allow the use of traditional elastic analysis (along with STM) for deflection checks. On the other hand, the FEM adopted by [spWall](#) reports deflection values for the entire model without the need of using other methods to complete the design ($\delta_{\max} = 0.037$ in. for this example as shown in Figure 19).

4. Comments, Observations and Conclusions

Deep beams such as transfer girders can be analyzed and designed by any procedure satisfying equilibrium and geometric compatibility. Two established methods are widely used.

The Strut-and-Tie Model or Method (STM) requires the designer to consciously select a realistic load path within the structural member in the form of an idealized truss. Rational detailing of the truss elements and compliance with equilibrium assures the safe transfer of loads to the supports or to other regions designed by conventional procedures. While solutions provided with this powerful analysis and design method are not unique, they represent a conservative lower bound approach. Compared with the prescriptive formulations in the body of ACI 318, the very visual, rational strut-and-tie modeling gives insight into detailing needs of irregular (load or geometric discontinuities) regions of concrete structures and promotes ductility at the strength limit stage. It also gives the engineer considerable control over modeling choices and ways to assert engineering judgement. The only serviceability provisions in the current Appendix A are the crack control reinforcement for the struts.

Finite Element Method (FEM) is another method for analyzing reinforced concrete deep beams, particularly useful for irregular beams and walls with variable thicknesses, openings, and other features that limit the use of STM or significantly complicate the STM truss and calculations. Many reputable commercial FEM analysis software packages are available on the market today such as [spWall](#). Using FEM requires critical understanding of the relationship between the actual behavior of the structure and the numerical simulation since this method is an approximate numerical method. FEM is based on several assumptions and the engineer has a great deal of decisions to make while setting up the model and applying loads and boundary conditions. The results obtained from FEM models should be verified to confirm their suitability for design and detailing of concrete structures.

A comparison between the resulting reinforcement calculated based on the two methods indicated somewhat comparable results with FEM indicating a higher resolution for reinforcement placement allowing for optimal utilization of the steel bars at locations where it is most needed. In the STM solution the concentration of bars in the tie location is also feasible but slightly more conservative.

The following table shows a general comparison between the STM and FEM analysis methods. This table covers general limitations, drawbacks, advantages, and cost-time efficiency of each method where it helps the engineer in deciding which method to use based on the project complexity, schedule, and budget.

Limitations/Applicability	Analysis Method	
	STM (Hand)	FEM (spWall)
Complexity	Easy to moderate (Calculations depend on the geometry of the structural member and selected truss/STM)	Moderate to complex (Software use is highly recommended)
Design time/costs	Highly dependent on the selected truss/STM	Fast/Costly
Design Economy	Conservative lower bound approach	Using appropriate mesh size and aspect ratio can produce economical and accurate design
General (Drawbacks)	Selecting a realistic load path within the structural member in the form of an idealized truss model can be challenging specially with complex geometry Detailed truss structural analysis is required Might lead to very conservative designs	Requires significant engineering judgment in making modeling assumptions to obtain an optimal design
General (Advantages)	Structural engineer has considerable control of the model selection and truss selection Engineering judgment and experience can be deployed to convert analysis and design results to creative and impactful reinforcement placement details to address complex and non-standard conditions	Unlimited applicability to handle complex/irregular situations permissible by the features of the software used (e.g. spWall) No need to select a load path and devise a truss. Exact load path and forces are expected from the analysis results